

ICH-104AT

12V Low Voltage, Max. 50W MR-16

4" IC Type Housing For New Construction

Catalog #		Type
Project		Date
Prepared by		

HALOGEN

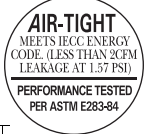

DESCRIPTION

The ICH-104AT is a 4" aperture low voltage housing for accent and task lighting.

APPLICATION

The ICH-104AT is designed for insulated ceilings and can be in direct contact with insulation material. The ICH-104AT offers a wide choice of trim types including reflector, lensed and wall wash trims. This AIR-TIGHT housing design prevents airflow through the ceiling, helping save on heating and cooling costs.

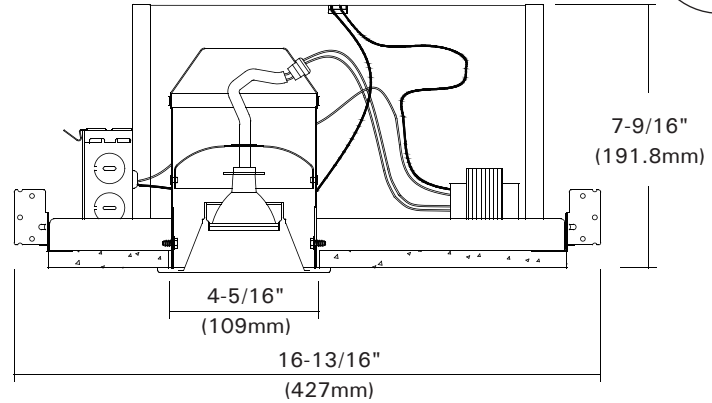

DESIGN FEATURES

Ceiling Cut-out : 4-3/8"
Lamp, Max. Watt. : 50W

• Housing

- Double wall aluminum housing.
- 7-1/16" height allows use in 2"X6" joist construction.
- Housing adjusts for ceilings up to 1-1/4" thick.

• Junction Box

- Listed for through branch circuit wiring. (Max. 8 No 12 AWG 90°C branch circuit conductors. (4 in, 4 out)
- (5) 1/2" knockouts with true pry-out slots and (4) knockouts with Romex cable clamp.
- Ground wire provided on J-box.

• Mounting Frame

- Galvanized steel construction.
- 9-1/8" x 14-7/8"

• Bar Hangers

- Maximum extension of 24" allows for extra distance between joists.
- Housing can be positioned at any point within 24" joist span.
- Score lines allow "toolless" shortening for 12" joists. Bar hangers may be repositioned 90 degrees.
- Integral T-bar clips snaps onto T-bars and no additional clips are required.

• Just-A-Nail

- Pre-installed nail bars with vertical slots are used to evenly align the bars horizontally after nailing halfway into wood joists.

• Socket

- Ceramic socket with aluminum heat shield for Bi Pin MR16 lamps.

• Lamp

- One 12V, 50W MR16 lamp. - See trim page for more details.

• Transformer

- 120V magnetic transformer steps line voltage down to lamp operating voltage for lamps up to 50W.
- Available 277V-12V transformer.

• Thermal Protector

- Self-resetting thermal detector deactivates fixture if overheating occurs due to improper lamping or insulation.

* Listing

- cCSA-us certificated.

• Just-A-Nail

Adjustable nail hanger bar for easy alignment.

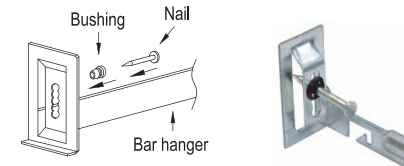

JUST-A-NAIL

• Optional "Quick Connect" Push-in wire connectors.

- Three "Quick Connectors"
- Pre-installed push-in wire connectors for fast and easy wiring.

• Compliance

- State of California Title 24.
- Washington State Energy Code.
- New York State Energy Conservation Construction Code.
- Energy Star Qualified.
- Certified AIR-TIGHT Under ASTM E283.

Trims

4" Halogen Trims For

DLH-304, DLH-304R, ICH-304AT, DLH-104, DLH-104R, ICH-104AT,
DLH-1043, DLH-1043R, DLH-1047, DLH-1047R

Catalog #		Type
Project		Date
Prepared by		

HALOGEN

TMH-24B Adjustable Baffle
NON-IC, IC : 50W MR16, 12V or 120V
DLH-1047 : 75W MR16, 12V
 White Metal Trim Ring
 O.D : 4-7/8"



TMH-24B-WH

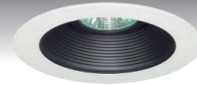

TMH-24B-BK



TMH-24B-CH

TMH-24R Adjustable Reflector
NON-IC, IC : 50W MR16, 12V or 120V
DLH-1047 : 75W MR16, 12V
 White Metal Trim Ring
 O.D : 4-7/8"



TMH-24R-CL



TMH-24R-GD

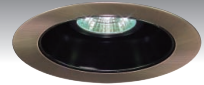

TMH-24R-BK-MO

TMH-48E Eyeball
NON-IC, IC : 50W MR16, 12V or 120V
DLH-1047 : 75W MR16, 12V
 White Metal Trim Ring
 O.D : 4-7/8"



TMH-48E-WH



TMH-48E-PB



TMH-48E-MO

TMH-43 Retractable Wall Wash
NON-IC, IC : 50W MR16, 12V
DLH-1047 : 75W MR16, 12V
 White Metal Trim Ring
 O.D : 4-7/8"



TMH-43-WH



TMH-43-CH



TMH-43-MO

TMH-47 Adjustable Wall Wash
NON-IC, IC : 50W MR16, 12V or 120V
DLH-1047 : 75W MR16, 12V
 White Metal Trim Ring
 O.D : 4-7/8"



TMH-47-WH



TMH-47-SN



TMH-47-AN

TMH-34P Pin Hole w/ Baffle
NON-IC : 50W MR16, 12V or 120V
IC : 35W MR16, 12V or 120V
DLH-1047 : 75W MR16, 12V
 White Metal Trim Ring
 O.D : 4-7/8"



TMH-34P-WH

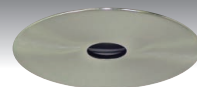

TMH-34P-SN

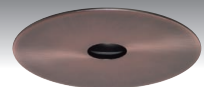

TMH-34P-MO

TMH-29 Slotted Wall Wash w/ Baffle
NON-IC : 50W MR16, 12V or 120V
IC : 35W MR16, 12V or 120V
DLH-1047 : 75W MR16, 12V
 White Metal Trim Ring
 O.D : 4-7/8"



TMH-29-WH



TMH-29-BK



TMH-29-BK-MO

TMH-28 Gimbal
NON-IC, IC : 50W MR16, 12V or 120V
DLH-1047 : 75W MR16, 12V
 White Metal Trim Ring
 O.D : 4-7/8"

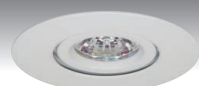

TMH-28-WH

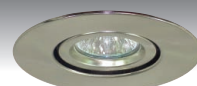

TMH-28-SN

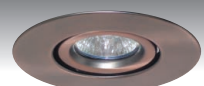

TMH-28-MO

Trims

4" Halogen Trims For

DLH-304, DLH-304R, ICH-304AT, DLH-104, DLH-104R, ICH-104AT,
DLH-1043, DLH-1043R, DLH-1047, DLH-1047R

Catalog #		Type
Project		Date
Prepared by		

HALOGEN

TMH-84E Eyeball w/ Baffle
NON-IC : 50W MR16, 12V or 120V
DLH-1047 : 75W MR16, 12V
 White Metal Trim Ring
 O.D : 4-7/8"



TMH-84E-WH



TMH-84E-BK



TMH-84E-BK-PB

TMH-35B Pin Spot
NON-IC : 50W MR16, 12V or 120V
IC : 35W MR16, 12V or 120V
DLH-1047 : 75W MR16, 12V
 White Metal Trim Ring
 O.D : 4-7/8"



TMH-35B-WH



TMH-35B-BK



TMH-35B-BK-SN

TMH-215 Shower Fresnel Lens
NON-IC : 50W MR16, 12V or 120V
IC : 35W MR16, 12V or 120V
DLH-1047 : 75W MR16, 12V
 White Metal Trim Ring
 O.D : 4-7/8"



TMH-215-WH



TMH-215-SN



TMH-215-MO

TMH-216 Shower Drop Opal Lens
NON-IC : 50W MR16, 12V or 120V
IC : 35W MR16, 12V or 120V
DLH-1047 : 75W MR16, 12V
 White Metal Trim Ring
 O.D : 4-7/8"



TMH-216-WH



TMH-216-SN



TMH-216-CH

TMH-217 Shower Albalite Lens
NON-IC : 50W MR16, 12V or 120V
IC : 35W MR16, 12V or 120V
DLH-1047 : 75W MR16, 12V
 White Metal Trim Ring
 O.D : 4-7/8"



TMH-217-WH

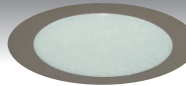

TMH-217-CH

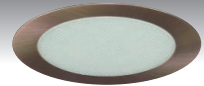

TMH-217-MO

TMH-25
 Wall Wash
NON-IC : 50W MR16, 12V or 120V
IC : 35W MR16, 12V or 120V
DLH-1047 : 75W MR16, 12V
 White Metal Trim Ring
 O.D : 4-7/8"



TMH-25-WH

TMH-25B
 Wall Wash w/ Baffle
NON-IC : 50W MR16, 12V or 120V
IC : 35W MR16, 12V or 120V
LH-4107 : 75W MR16, 12V
 White Metal Trim Ring
 O.D : 4-7/8"



TMH-25B-WH



TMH-25B-BK

ORDERING INFORMATION

Choose the catalog / finish codes that best suit your needs and enter it on the appropriate line.

TRIM MODEL	REFLECTOR	BAFFLE	METAL RING
	CL :Clear	WH :White	WH :White
	WH :White	BK :Black	BK :Black
	GD :Gold	SN :Satin Nickel	SN :Satin Nickel
	MA :Matte Platinum	AN :Antique Nickel	AN :Antique Nickel
	CP :Champagne	AC :Antique Copper	AC :Antique Copper
	PR :Pewter	MO :Mocha	MO :Mocha
	HC :Haze Clear	CA :Cappuccino	CA :Cappuccino
		CH :Chrome	CH :Chrome
		UN :Natural Steel	UN :Natural Steel
		PB :Polished Brass	PB :Polished Brass

Examples:

TMH-43-WH = Retractable White Wall Wash
 TMH-24B-BK-WH = White Metal Trim Ring w/ Black Baffle
 TMH-35B-BK-WH = White Trim Ring w/ Black Baffle